

Article number: 03504200

Description: Fluro Rod end GE 200LO

Measures

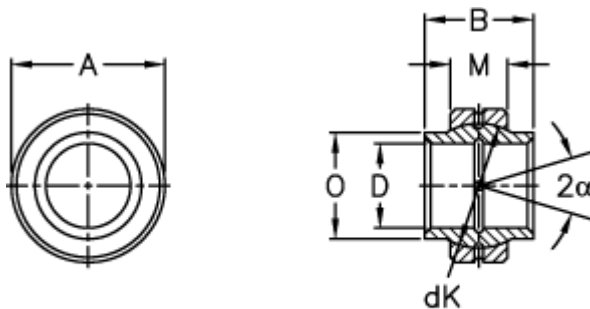

Str. 12 den smørerille

A	= 290 0 -0,035	Tilt angle = 4
B	= 200	Weight = 32500
D	= 200 0 +0,046	
dK	= 250	
Dynamic load C (kN)	= 2120	
M	= 100	
O	= 221	
Static load C0 (kN)	= 10600	